

SECTION X



Table of Contents



Decorator Products



USB Charger Receptacles and Outlets



Power Delivery



Decorator Products	Page
Quiet Rocker Switches	X-3
Combination Quiet Rocker Switches/Devices	X-4
Standard Receptacles, Weather Resistant Tamper-Resistant and Single Receptacles	X-5
USB Charger Receptacles and Outlets	X-7
GFCI Receptacles with Auto Grounding	X-8
Recessed Receptacles and AV Wallboxes	X-9
Decorator Frames and Modular Snap Fit Jacks	X-10
Molded-In Voice/Data/Video	X-11
Plastic and Metal Wallplates	X-12
Combination Wallplates	X-13
Switches and Receptacles	
Toggle Switches	X-14
Combination Switches/Devices	X-15
Duplex and Single Receptacles	X-16
Range and Dryer Power Receptacles and Plugs	X-17
Special Use Products	X-18

Lighting Controls	Page
CFL/LED, Toggle, Rotary Dimmers and Fan Speed Controls	X-19
Dimmers and Fan Speed Controls	X-20
Wall Switches and Digital Timer	X-21
Power Delivery	
Floor Boxes for Wood Floors	X-22
Floor Boxes for Concrete Floors	X-24
Under Cabinet/Counter Power Distribution	X-25
JLOAD® Multimedia Outlet	X-26



Products at a Glance

Residential Decorator Switches and Receptacles provide more than solid, dependable function alone. Indeed, they are fashion statements, masterfully complementing the look and feel of any room in any home.

Decorator Products - Smart Style, Good Looks



Decorator Switches

- Smooth, quiet rocker
- Self-grounding feature is standard
- Nightlight version is available
- Ultrasonically welded cover and base
- Operating temperature: -20°C to 60°C
- UL Listed E3896, CSA Certified



Decorator Duplex Receptacles

- Self-grounding feature is standard
- Tamper and Weather Resistant availability
- Multiple-drive Slot/Phillips/Robertson head screws
- Nightlight version is available
- Hi-visibility yellow base for easy installation
- Operating temperature: -20°C to 60°C
- UL Listed, CSA Certified



USB Charger Receptacles

- Two USB ports 5 Amp, 5V DC
- Tamper-Resistant duplex receptacle
- Standard and Hospital grade
- cULus listed to UL498 and UL1310

4 Port and 2 Port USB Outlets

- 4 Port (5 Amp) and 2 Port (3 Amp), 5V DC
- Switch activated port door; when open enables power; when closed, all power is switched OFF, for a “zero” no-load draw
- Shallow depth design for two port



Decorator Frames and Modular Jacks

- Elongated strap for better wall box mounting
- Designed to complement decorator styling
- These jacks offer voice and Cat. 5e devices to fit within a decorator wallplate
- UL Listed 1863 - Communication Circuit Accessory and CSA Certified



Features

A Perfect Match

- Residential decorator devices and wallplates blend in beautifully with all kinds of wall coverings

Easy-Activate Rockers

- Ideal for use in assisted-living environments— or any living environment

Mini-Rocker Switches

- Take up less space and provide full function

Flush and Contemporary

- Sleek, smart and appealing, Residential devices add beautiful, fashionable, highly-styled devices to any home

Nightlight Switches and Receptacles

- Provides safety light with energy efficiency

Decorator Quiet Rocker Switches

Features

- Smooth, quiet rocker
- Self-grounding feature is standard
- Ultrasonically welded cover and base
- Operating temperature: -20°C to 60°C
- UL Listed E3896, CSA Certified

Single Pole Decorator Quiet Rocker Switches

Description	Single Pole	Single Pole, Illuminated	Single Pole, Pilot Light	Single Pole with Nightlight	Single Pole with ON/OFF Marking
Termination	Self-Grounding, Push, Back and Side Wire	Self-Grounding, Push, Back and Side Wire	Self-Grounding, Push, Back and Side Wire	Self-Grounding, Push, Back and Side Wire	Self-Grounding, Push, Back and Side Wire
Rating	15A 120-277V AC	15A 120V AC	15A 120V AC	20A 120-277V AC	15A 120-277V AC
Black	RSD115BK	—	—	DS120NLBK*	—
Brown	RSD115	—	—	DS120NLBR*	—
Gray	RSD115GY	—	—	DS120NLGY*	—
Ivory	RSD115I	RSD115ILI*	RSD115PLI**	DS120NLIV*	RSD115IM
Light Almond	RSD115LA	RSD115ILLA*	RSD115PLLA**	DS120NLLA*	RSD115LAM
White	RSD115W	RSD115ILW*	RSD115PLW**	DS120NLWH*	RSD115WM

Note: *Light glows through the top portion of the rocker when switch is in the OFF position. Does not require a neutral wire.

**Light glows through the lens in the rocker when switch is in the ON position. Requires a neutral wire.



RSD115W



RSD115PLW

Double Pole, Three Way and Four Way Decorator Quiet Rocker Switches

Description	Double Pole	Three Way	Three Way, Illuminated	Four Way
Termination	Self-Grounding, Back and Side Wire	Self-Grounding, Push, Back and Side Wire	Self-Grounding, Push, Back and Side Wire	Self-Grounding, Back and Side Wire
Rating	15A 120-277V AC	15A 120-277V AC	15A 120V AC	15A 120-277V AC
Black	RSD215BK	RSD315BK	—	RSD415BK
Brown	RSD215	RSD315	—	RSD415
Gray	RSD215GY	RSD315GY	—	RSD415GY
Ivory	RSD215I	RSD315I	RSD315ILI*	RSD415I
Light Almond	RSD215LA	RSD315LA	RSD315ILLA*	RSD415LA
White	RSD215W	RSD315W	RSD315ILW*	RSD415W

Note: *Light glows through the top portion of the rocker when switch is in the OFF position. Does not require a neutral wire.



DS120NLWH



RSD115WM



RSD215W

Dimensions

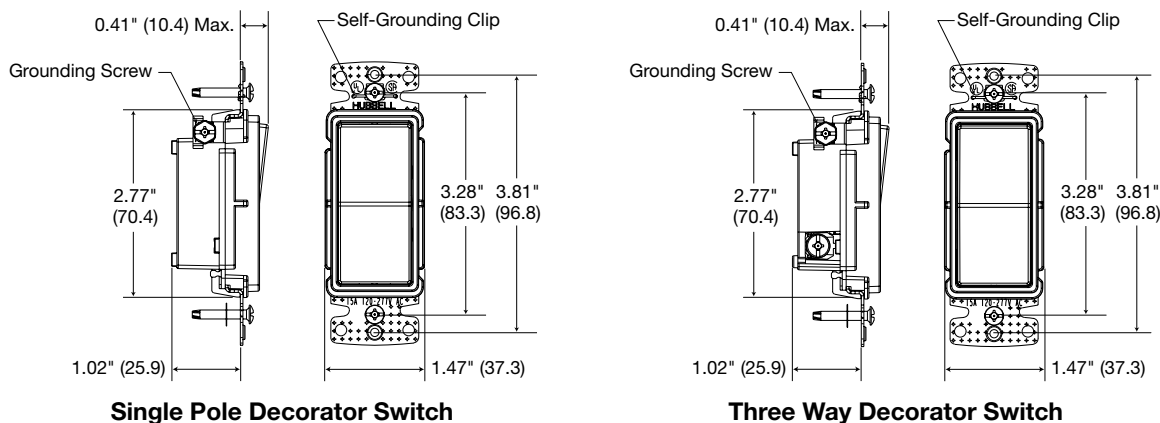

Dimensions in Inches (mm)



Decorator Combination Quiet Rocker Switches/Devices

Features

- Low profile, less than 1 inch deep
- Self-grounding feature is standard
- Operating temperature: -20°C to 60°C
- UL Listed E3896, CSA Certified



RCD111W



RCD101W



RCD108W



RCD109W



DD100NLWH

Combination Quiet Rocker Switches/Devices

Description	Three (3) Single Pole Switches	Two (2) Single Pole Switches	Single Pole and Three Way Switch	Single Pole Switch, 2 Pole, 3 Wire Receptacle
Termination	Self-Grounding, Side Wire	Self-Grounding, Side Wire	Self-Grounding, Side Wire	Self-Grounding, Side Wire
Rating	15A 120-277V AC	15A 120-277V AC	15A 120-277V AC	15A 120V (switch) 15A 125V (recept.) NEMA 5-15R
Black	—	RCD101BK	RCD103BK	RCD108BK
Gray	—	RCD101GY	RCD103GY	RCD108GY
Ivory	RCD111I	RCD101I	RCD103I	RCD108I
Light Almond	RCD111LA	RCD101LA	RCD103LA	RCD108LA
White	RCD111W	RCD101W	RCD103W	RCD108W

Description	Single Pole Switch, Tamper-Resistant, 2 Pole, 3 Wire, Receptacle	Two (2) Three Way Switches	Three Way Switch, Tamper-Resistant, 2 Pole, 3 Wire, Receptacle	Three Way Switch, 2 Pole, 3 Wire Receptacle
Termination	Self-Grounding, Side Wire	Self-Grounding, Side Wire	Self-Grounding, Side Wire	Self-Grounding, Side Wire
Rating	15A 120V (switch) 15A 125V (recept.) NEMA 5-15R	15A 120-277V AC	15A 120V (switch) 15A 125V (recept.) NEMA 5-15R	15A 120V (switch) 15A 125V (recept.) NEMA 5-15R
Black	RCD108BKTR	RCD303BK	RCD308BKTR	RCD308BK
Gray	RCD108GYTR	RCD303GY	RCD308GYTR	—
Ivory	RCD108ITR	RCD303I	RCD308ITR	RCD308I
Light Almond	RCD108LATR	RCD303LA	RCD308LATR	RCD308LA
White	RCD108WTR	RCD303W	RCD308WTR	RCD308W

Description	Single Pole Switch, Pilot Light, Clear Lens, Amber Neon Bulb	Three Way Switch, Pilot Light, Clear Lens, Amber Neon Bulb	Nightlight Only
Termination	Self-Grounding, Side Wire	Self-Grounding, Side Wire	Self-Grounding, 6" Pre-wired Stranded Wire, 1/2" Stripped Ends
Rating	15A 120V	15A 120V	120V
Black	—	—	—
Gray	—	—	—
Ivory	RCD109I**	RCD309I**	DD100NLIV**
Light Almond	RCD109LA**	RCD309LA**	DD100NLLA**
White	RCD109W**	RCD309W**	DD100NLWH**

Note: *See Technical section, page 10 for Tamper-Resistant description.
**Requires neutral wire.

Pilot Light Wiring Diagram

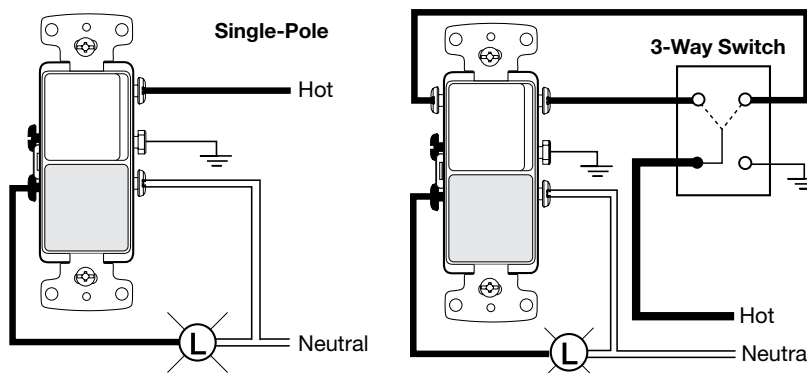

Dimensions in Inches (mm)

Decorator Weather Resistant, Tamper-Resistant, Standard and Single Receptacles

Decorator Duplex Receptacles, 2 Pole, 3 Wire

Description	* * Weather and Tamper-Resistant	* Tamper-Resistant	Standard	Standard
Termination	Self-Grounding, Push and Side Wire	Self-Grounding, Push and Side Wire	Self-Grounding, Push and Side Wire	Push and Side Wire
Rating	15A 125V NEMA 5-15R	15A 125V NEMA 5-15R	15A 125V NEMA 5-15R	15A 125V NEMA 5-15R
Black	RRD15SBKWRTR	RRD15SBKTR	RRD15SBK	RRD15BK
Brown	RRD15SWRTR	RRD15STR	RRD15S	RRD15
Gray	RRD15SGYWRTR	RRD15SGYTR	RRD15SGY	RRD15GY
Ivory	RRD15SIWRTR	RRD15SITR	RRD15SI	RRD15I
Light Almond	RRD15SLAWRTR	RRD15SLATR	RRD15SLA	RRD15LA
White	RRD15SWRTR	RRD15SWTR	RRD15SW	RRD15W



RRD15SWTR

Description	* Tamper-Resistant, Nightlight Receptacle	* Tamper-Resistant	* Tamper-Resistant, Without Ears**	Standard, Without Ears**
Termination	Self-Grounding, Two Nightlight Sources for 0.5 Lumens Total, Back and Side Wired	Self-Grounding, Eight Push Wire Holes Only #14 AWG	Self-Grounding, Push and Side Wire	Self-Grounding, Push and Side Wire
Rating	15A 125V NEMA 5-15R	15A 125V NEMA 5-15R	15A 125V NEMA 5-15R	15A 125V NEMA 5-15R
Black	—	RRD15EBKTR	RRD15KBKTR	RRD15KBK
Brown	—	RRD15ETR	RRD15KTR	RRD15K
Gray	—	RRD15EGYTR	RRD15KGYTR	RRD15KGY
Ivory	DR15NLIV	RRD15EITR	RRD15KITR	RRD15KI
Light Almond	DR15NLLA	RRD15ELATR	RRD15KLATR	RRD15KLA
White	DR15NLWH	RRD15EWTR	RRD15KWTR	RRD15KW



RRD15SW



DR15NLWH

Note: *See Technical section, page 10 for Weather and Tamper-Resistant descriptions.

**100 per case, bulk packed. Mounting screws inserted into strap.

Decorator Single Receptacles, 2 Pole, 3 Wire

Description	* Tamper-Resistant	Standard	* Tamper-Resistant	Standard
Termination	Self-Grounding, Side Wire	Self-Grounding, Side Wire	Self-Grounding, Side Wire	Self-Grounding, Side Wire
Rating	15A 125V NEMA 5-15R	15A 125V NEMA 5-15R	20A 125V NEMA 5-20R	20A 125V NEMA 5-20R
Black	RRD151BKTR	RRD151BK	RRD201BKTR	RRD201BK
Brown	RRD151TR	RRD151	RRD201TR	RRD201
Gray	RRD151GYTR	RRD151GY	RRD201GYTR	RRD201GY
Ivory	RRD151ITR	RRD151I	RRD201ITR	RRD201I
Light Almond	RRD151LATR	RRD151LA	RRD201LATR	RRD201LA
White	RRD151WTR	RRD151W	RRD201WTR	RRD201W



RRD151W

Description	Standard	Standard
Termination	Self-Grounding, Side Wire	Self-Grounding, Side Wire
Rating	15A 250V NEMA 6-15R	20A 250V NEMA 6-20R
Black	RRD155BK	RRD205BK
Brown	RRD155	RRD205
Gray	RRD155GY	RRD205GY
Ivory	RRD155I	RRD205I
Light Almond	RRD155LA	RRD205LA
White	RRD155W	RRD205W



RRD205W

Note: *See Technical section, page 10 for Tamper-Resistant description.

Dimensions in Inches (mm)



Products at a Glance

Hubbell USB Chargers are available in the new Type-C port, a combination unit with Type A and C, and the legacy Type A, all with more power. The increase in power to a 5 Amp 5 Volt USB port adds capacity so that there is always ample current to support multiple device charging. Portable mobile manufacturers recently announced products using the faster Type-C ports. More phones, tablets and other electronic devices are expected to use this new standard.

USB Charger Receptacles and Outlets



USB Charger Receptacles

- Two Type-C and Type A&C port configurations, high power 5 Amp, 5 Volt USB output
- Standard and Hospital grade
- Heavy duty stainless steel USB ports; rated for 10,000 cord insertions and removals
- Patented Hubbell Tamper-Resistant technology uses cam action shutters. The friction-free design of the mechanism's doors requires much less force, allowing the plug to slide in effortlessly



USB Charger Receptacles

- Two Type A port configurations, high power 5 Amp, 5 Volt USB output
- Standard and Hospital grade
- Heavy duty stainless steel USB ports; rated for 10,000 cord insertions and removals
- Patented Hubbell Tamper-Resistant technology uses cam action shutters. The friction-free design of the mechanism's doors requires much less force, allowing the plug to slide in effortlessly



4 Port and 2 Port Features

- 4 Port (5 Amp) and 2 Port (3 Amp), 5V DC, type A, class 2.0
- Switch activated port door; when open enables power. When closed, all power is switched off, for a "zero" no-load draw
- Shallow depth design for two port
- 4 port USB - cETLus listed to UL1310
- 2 port USB - cULus listed to UL1310



Switch Combo Outlets

- Two USB ports 2.1 Amp, 5Volt DC, type A, class 2.0
- Isolated 15 Amp, 120V AC single pole/3-way switch
- cULus listed to UL20 and UL1310



Typical Applications

Ideal for use in renovation, new construction and to add capacity for USB charging. Especially suited for use in hotels, hospitals, schools, offices, homes and more.



Hotels



Healthcare



Schools



Offices



Residential



USB Charger Receptacles and Outlets



USB Charger Type-C

Description	Color	15A 125V	20A 125V
USB Charger Outlet: two Type-C port configurations, high power 5 Amp, 5 Volt USB output, USB ports rated 10,000 cycles, Commercial Grade Tamper-Resistant duplex receptacle. Available in Hospital grade, see section A or L.	Black	USB15C5BK	USB20C5BK
	Brown	USB15C5	USB20C5
	Gray	USB15C5GY	USB20C5GY
	Ivory	USB15C5I	USB20C5I
	Light Almond	USB15C5LA	USB20C5LA
	White	USB15C5W	USB20C5W

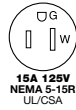

USB15C5W

USB Charger Combination Type A&C

Description	Color	15A 125V	20A 125V
USB Charger Outlet: one Type A and one Type-C port configurations, high power 5 Amp, 5 Volt USB output, USB ports rated 10,000 cycles, Commercial Grade Tamper-Resistant duplex receptacle. Available in Hospital grade, see section A or L.	Black	USB15AC5BK	USB20AC5BK
	Brown	USB15AC5	USB20AC5
	Gray	USB15AC5GY	USB20AC5GY
	Ivory	USB15AC5I	USB20AC5I
	Light Almond	USB15AC5LA	USB20AC5LA
	White	USB15AC5W	USB20AC5W



USB15AC5W

USB Charger Type A

Description	Color	15A 125V	20A 125V
USB Charger Outlet: two Type A port configurations, high power 5 Amp, 5 Volt USB output, USB ports rated 10,000 cycles, Commercial Grade Tamper-Resistant duplex receptacle. Available in Hospital grade, see section A or L.	Black	USB15A5BK	USB20A5BK
	Brown	USB15A5	USB20A5
	Gray	USB15A5GY	USB20A5GY
	Ivory	USB15A5I	USB20A5I
	Light Almond	USB15A5LA	USB20A5LA
	White	USB15A5W	USB20A5W



USB20A5W

USB Charger Outlets

Description	Color	4 Port Outlet, 5 Amp, 5 Volt DC	2 Port Outlet, Shallow Profile, 3 Amp, 5 Volt DC
USB Charger 2 or 4 Port Outlets, USB Type 2.0 Ports, decorator.	Black	USB4BK	USB2BK
	Brown	USB4	USB2
	Gray	USB4GY	USB2GY
	Ivory	USB4I	USB2I
	Light Almond	USB4LA	USB2LA
	White	USB4W	USB2W



USB4W

Switch Combo Outlets

Description	Color	Catalog Number
Switch Combo Outlet, two USB type 2.0 ports, 2.1 Amp, 5 Volt DC, Style Line® decorator	Black	USB102BK
	Brown	USB102
	Gray	USB102GY
	Ivory	USB102I
	Light Almond	USB102LA
	White	USB102W



USB2W



USB102W



Meets UL Standard
943 Class A GFCI

GFCI Receptacles with Auto Grounding

Features

- Patented AUTOGUARD® self test technology includes disconnecting power to the receptacle if critical components are damaged and GFCI protection is lost
- Internal back wiring clamp and guide for quick and secure termination
- Night light option includes light sensor controls for automatic ON and OFF, custom dual lens for optimum light output



GFRST15WNL

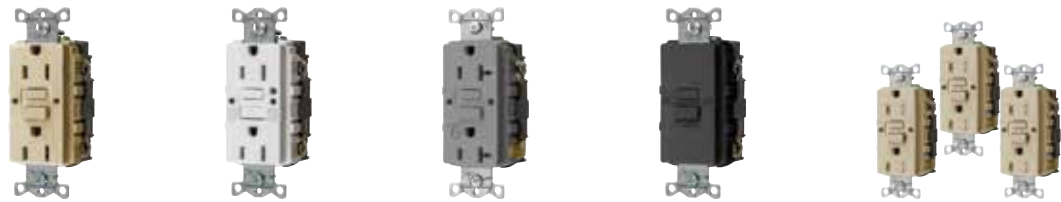

Standard

Rating	Color	Standard	Night Light Two LED Night Lights	Alarm	Blank Face Available in 20A Only	Standard 3-Pack Three Devices per Pack
	Almond	GFRST15AL	GFRST15ALNL	GFRST15ALB	—	—
	Black	GFRST15BK	GFRST15BKNL	GFRST15BKB	—	—
	Brown	GFRST15	GFRST15NL	GFRST15B	—	—
	Gray	GFRST15GY	GFRST15GYNL	GFRST15GYB	—	—
	Ivory	GFRST15I	GFRST15INL	GFRST15IB	—	GFRST15I3
	Light Almond	GFRST15LA	GFRST15LANL	GFRST15LAB	—	GFRST15LA3
	Red	GFRST15R	GFRST15RNL	GFRST15RB	—	—
	White	GFRST15W	GFRST15WNL	GFRST15WB	—	GFRST15W3
	Almond	GFRST20AL	GFRST20ALNL	GFRST20ALB	GFBFST20AL	—
	Black	GFRST20BK	GFRST20BKNL	GFRST20BKB	GFBFST20BK	—
	Brown	GFRST20	GFRST20NL	GFRST20B	GFBFST20	—
	Gray	GFRST20GY	GFRST20GYNL	GFRST20GYB	GFBFST20GY	—
	Ivory	GFRST20I	GFRST20INL	GFRST20IB	GFBFST20I	GFRST20I3
	Light Almond	GFRST20LA	GFRST20LANL	GFRST20LAB	GFBFST20LA	GFRST20LA3
	Red	GFRST20R	GFRST20RNL	GFRST20RB	GFBFST20R	—
	White	GFRST20W	GFRST20WNL	GFRST20WB	GFBFST20W	GFRST20W3



Tamper-Resistant Weather Resistant

Rating	Color	Standard	Isolated Ground
	Almond	GFTWRST15AL	GFTWRST15ALIG
	Black	GFTWRST15BK	GFTWRST15BKIG
	Brown	GFTWRST15	GFTWRST15IG
	Gray	GFTWRST15GY	GFTWRST15GYIG
	Ivory	GFTWRST15I	GFTWRST15IIG
	Light Almond	GFTWRST15LA	GFTWRST15LAIG
	Red	GFTWRST15R	GFTWRST15RIG
	White	GFTWRST15W	GFTWRST15WIG
	Almond	GFTWRST20AL	GFTWRST20ALIG
	Black	GFTWRST20BK	GFTWRST20BKIG
	Brown	GFTWRST20	GFTWRST20IG
	Gray	GFTWRST20GY	GFTWRST20GYIG
	Ivory	GFTWRST20I	GFTWRST20IIG
	Light Almond	GFTWRST20LA	GFTWRST20LAIG
	Red	GFTWRST20R	GFTWRST20RIG
	White	GFTWRST20W	GFTWRST20WIG

Recessed Receptacles and AV Wallboxes

Hubbell has solutions for residential environments where wire management is a concern. Products sit flush against the wall and are available in multiple colors, creating an aesthetically pleasing look. Large connectors and cables are held securely and bundled together neatly. Wires are concealed behind the wall and out of view. Snap Fit options are used for customizing your connections.

Features

Receptacles

- Snap Fit is configurable to accommodate multiple connectors such as: HDMI, AV, and Voice/Low-Speed Data
- Feed-Through options allows you to make direct connections
- 15A 125V
- Back and side wired

Boxes

- Available in plastic or metal boxes to accommodate local building requirements



Recessed Receptacle with Feed-Through

Metal Wallbox

Recessed Receptacles



Color	15A 125V, Tamper-Resistant Duplex Receptacle		
	1-Gang	2-Gang with Feed-Through	2-Gang with Snap Fit
Ivory	RR1510I	RR1512I	RR1514I
Light Almond	RR1510LA	RR1512LA	RR1514LA
White	RR1510W	RR1512W	RR1514W

Feed-Through Plates



Color	1-Gang	2-Gang
Ivory	NSAV1I*	NSAV2I*
White	NSAV1W*	NSAV2W*

Note: *Not UL Listed.

Two and Three Gangable AV Wallboxes



Box	Dimensions			Top Knockouts	Bottom Knockouts	Back Knockouts	Catalog Number
	Height	Width	Depth				
2-Gang, 2" KO, 54 in ³ capacity	4.21" (107)	4.06" (103)	4.0" (102)	(2) 1/2" (2) 1/2" - 3/4" TKO*	(1) 1", 1 1/4", 1 1/2" and 2"	(2) 1/2" - 3/4" TKO	HBL985
3-Gang, 2" KO, 79 in ³ capacity	4.21" (107)	5.87" (149)	4.0" (102)	(3) 1/2" (3) 1/2" - 3/4" TKO*	(1) 1/2", (1) 1/2" - 3/4" TKO* (1) 1", 1 1/4", 1 1/2" and 2"	(3) 1/2" - 3/4" TKO	HBL986

Note: *TKO (Tangential Knockout).

Wallbox

Description	Color	Catalog Number
2-Gang, nail-on box, thermoplastic	Blue	RR1500

Low Voltage AV Wallbox Partitions

Compatible With	Description	Quantity	Catalog Number
HBL985 and HBL986	Solid divider	1	HBL989
	With pass-Through capability	1	HBL989AVD

Dimensions in Inches (mm)



Decorator Frames and Modular Snap Fit Jacks

Decorator Frames



Color	1-Gang, 2-Port	1-Gang, 3-Port	1-Gang, 4-Port	1-Gang, 6-Port	1-Gang, Adapter .406" (10.30) Dia. Hole*	1-Gang, Adapter Blank**
Black	NS612BK	NS613BK	NS614BK	NS616BK	—	NS620BK
Gray	NS612GY	NS613GY	NS614GY	NS616GY	—	NS620GY
Ivory	NS612I	NS613I	NS614I	NS616I	NS621I	NS620I
Light Almond	NS612LA	NS613LA	NS614LA	NS616LA	NS621LA	NS620LA
White	NS612W	NS613W	NS614W	NS616W	NS621W	NS620W

Note: *For use with rotary dimmers or to pull through AV or telephone cable.
**To fill an extra decorator opening or to create customized openings.

Molded-In Voice/Low-Speed Data - Modular Snap Fit



Category 6 Jack



Category 5e Jack



USOC Jack

Color	Category 6 Jack		Category 5e Jack		USOC Jack (single)
	(single)	(25 pack)	(single)	(25 pack)	
Black	NSJ6BK	NSJ6BK25	NSJ5EBK	NSJ5EBK25	NSJUBK
Blue	NSJ6B	NSJ6B25	NSJ5EB	NSJ5EB25	NSJUB
Gray	NSJ6GY	NSJ6GY25	NSJ5EGY	NSJ5EGY25	NSJUGY
Green	NSJ6GN	NSJ6GN25	NSJ5EGN	NSJ5EGN25	NSJUGN
Ivory	NSJ6I	NSJ6I25	NSJ5EI	NSJ5EI25	NSJUI
Light Almond	NSJ6LA	NSJ6LA25	NSJ5ELA	NSJ5ELA25	NSJULA
Orange	NSJ6OR	NSJ6OR25	NSJ5EOR	NSJ5EOR25	NSJUOR
Red	NSJ6R	NSJ6R25	NSJ5ER	NSJ5ER25	NSJUR
White	NSJ6W	NSJ6W25	NSJ5EW	NSJ5EW25	NSJUW
Yellow	NSJ6Y	NSJ6Y25	NSJ5EY	NSJ5EY25	NSJUY

Audio/Video Connectors - Standard Bulkhead



Color	Nickel F-Type Coupler Bulkhead, Female to Female	Gold F-Type Coupler Bulkhead, Female to Female	RCA Gold Pass Through, Female to Female, Red Interior	RCA Gold Pass Through, Female to Female, White Interior	RCA Gold Pass Through, Female to Female, Yellow Interior	RCA Gold Pass Through, Female to Female, Blue Interior	RCA Gold Pass Through, Female to Female, Green Interior
Black	NSF70BK	SFFGBK	SFRCRFFBK	SFRCWFFBK	SFRCYFFBK	SFRCBFFBK	SFRCGNFFBK
Gray	NSF70GY	SFFGGY	SFRCRFFGY	SFRCWFFGY	SFRCYFFGY	SFRCBFFGY	SFRCGNFFGY
Ivory	NSF70I	SFFGEI	SFRCRFFEI	SFRCWFFEI	SFRCYFFEI	SFRCBFFEI	SFRCGNFFEI
Light Almond	NSF70LA	SFFGLA	SFRCRFFLA	SFRCWFFLA	SFRCYFFLA	SFRCBFFLA	SFRCGNFFLA
White	NSF70W	SFFGW	SFRCRFFW	SFRCWFFW	SFRCYFFW	SFRCBFFW	SFRCGNFFW

Audio/Video Connectors - Recessed



Color	Gold F-Type Coupler Bulkhead, Female to Female	RCA Gold Pass Through, Female to Female, Red Interior	RCA Gold Pass Through, Female to Female, White Interior	RCA Gold Pass Through, Female to Female, Yellow Interior	RCA Gold Pass Through, Female to Female, Blue Interior	RCA Gold Pass Through, Female to Female, Green Interior	Blank Insert
Black	SFGRFBK	SFRCRRBK	SFRCWRBK	SFRCYRBK	SFRCBRBK	SFRCGNRBK	SFSBBK10*
Gray	SFGRFGY	SFRCRRGY	SFRCWRGY	SFRCYRGY	SFRCBRGY	SFRCGNRGY	SFSBGY10*
Ivory	SFGRFEI	SFRCRREI	SFRCWREI	SFRCYREI	SFRCBREI	SFRCGNREI	SFSBEI10*
Light Almond	SFGRFLA	SFRCRRLA	SFRCWRLA	SFRCYRLA	SFRCBRLA	SFRCGNRLA	SFSBLA10*
White	SFGRFW	SFRCRRW	SFRCWRW	SFRCYRW	SFRCBRW	SFRCGNRW	SFSBW10*

Note: *Sold in a package of 10. Order 1 to receive a bag of 10 blanks.

Dimensions in Inches (mm)

Molded-In Voice/Data/Video

Features

Designed to complement decorator styling, these jacks offer voice and Cat. 5e devices to fit within a decorator wallplate.

- High impact-resistant thermoplastic frame
- Meets FCC part 68
- UL Listed 1863 - Communication Circuit Accessory and CSA Certified

Molded-In Voice/Low-Speed Data

Description	Decorator Frame, One RJ11 Jack, 6-Position, 4-Conductor	Decorator Frame, One RJ11 Jack, 6-Position, 6-Conductor	Decorator Frame, Duplex RJ11 Jacks, 6-Position, 6-Conductor	Decorator Frame, One Cat. 5e One RJ11 Jack, 6-Position, 4-Conductor
Termination	Screw Terminations	Screw Terminations	Screw Terminations	110 Punch-Down
Color				
Black	NS770BK	—	—	NS784BK
Brown	NS770	NS771	—	NS784
Gray	NS770GY	—	—	NS784GY
Ivory	NS770I	NS771I	NS772I	NS784I
Light Almond	NS770LA	NS771LA	NS772LA	NS784LA
White	NS770W	NS771W	NS772W	NS784W

Features

Coaxial video and combination jacks complement multimedia needs in a 1-gang decorator opening.

- High impact-resistant thermoplastic frame
- Jacks meet FCC part 68
- UL Listed 1863 - Communication Circuit Accessory and CSA Certified

Molded-In Voice/Low-Speed Data

Description	Decorator Frame, Single F-Type Coupler Bulkhead, Female to Female	Decorator Frame, Duplex F-Type Coupler Bulkhead, Female to Female	Decorator Frame, One RJ11 Jack, 6-Position, 4-Conductor, One F-Type Coupler Bulkhead, Female to Female	Decorator Frame, One Cat. 5e One F-Type Coupler Bulkhead, Female to Female
Termination	Screw Terminations	Screw Terminations	Screw Terminations	110 Punch-Down
Color				
Black	—	—	—	NS785BK
Brown	—	—	—	NS785
Gray	—	—	—	NS785GY
Ivory	NS780I	NS782I	NS783I	NS785I
Light Almond	NS780LA	NS782LA	NS783LA	NS785LA
White	NS780W	NS782W	NS783W	NS785W

Dimensions in Inches (mm)



Plastic and Metal Wallplates

More Style In a Snap

Snap-on wallplates offer a clean, elegant look that can be installed in seconds. Screw the mounting plate onto the device and press the snap-on cover into place. Four snaps securely hold the cover to the sub-plate.

- Clean, elegant look
- No visible screws
- Snap-on cover plate completely covers sub-plate eliminating dirt build-up around the edges
- Snap-on cover plate hides any paint or scratches on sub-plate caused during installation
- Appearance is consistent with other Hubbell wallplates
- Meets UL and CSA standards



Snap-On Wallplates

Color	1-Gang, 1-Decorator	1-Gang, 1-Duplex	1-Gang, 1-Toggle	2-Gang, 2-Decorator	2-Gang, 2-Toggle	3-Gang, 3-Decorator	3-Gang, 3-Toggle	4-Gang, 4-Decorator
Ivory	NP126I	NPS8I	NPS1I	NPS262I	NPS2I	NPS263I	NPS3I	NPS264I
Light Almond	NP126LA	NPS8LA	NPS1LA	NPS262LA	NPS2LA	NPS263LA	NPS3LA	NPS264LA
White	NP126W	NPS8W	NPS1W	NPS262W	NPS2W	NPS263W	NPS3W	NPS264W

Decorator, Screw-On, Standard, Nylon Wallplates

Color	1-Gang, 1-Decorator	2-Gang, 2-Decorator	3-Gang, 3-Decorator	4-Gang, 4-Decorator	5-Gang, 5-Decorator	6-Gang, 6-Decorator
Black	NP26BK	NP262BK	NP263BK	NP264BK	NP265BK	NP266BK
Brown	NP26	NP262	NP263	NP264	NP265	NP266
Gray	NP26GY	NP262GY	NP263GY	NP264GY	NP265GY	NP266GY
Ivory	NP26I	NP262I	NP263I	NP264I	NP265I	NP266I
Light Almond	NP26LA	NP262LA	NP263LA	NP264LA	NP265LA	NP266LA
White	NP26W	NP262W	NP263W	NP264W	NP265W	NP266W

Decorator, Screw-On, Mid-Size, Nylon Wallplates

Color	1-Gang, 1-Decorator	2-Gang, 2-Decorator	3-Gang, 3-Decorator	4-Gang, 4-Decorator	5-Gang, 5-Decorator	6-Gang, 6-Decorator
Black	NPJ26BK	NPJ262BK	NPJ263BK	NPJ264BK	—	—
Brown	NPJ26	NPJ262	NPJ263	NPJ264	—	—
Gray	NPJ26GY	NPJ262GY	NPJ263GY	NPJ264GY	—	—
Ivory	NPJ26I	NPJ262I	NPJ263I	NPJ264I	—	—
Light Almond	NPJ26LA	NPJ262LA	NPJ263LA	NPJ264LA	—	—
White	NPJ26W	NPJ262W	NPJ263W	NPJ264W	—	—

Decorator, Screw-On, Mid-Size, Metal Wallplates

Material	1-Gang, 1-Decorator	2-Gang, 2-Decorator	3-Gang, 3-Decorator	4-Gang, 4-Decorator	5-Gang, 5-Decorator	6-Gang, 6-Decorator
Brass	SB26	SB262	—	—	—	—
Brass Plated	SBP26	SBP262	SBP263	—	—	—
Chrome	SCH26	SCH262	—	—	—	—
S/S 302/304	SS26	SS262	SS263	SS264	SS265	SS266
S/S 430	SS26L	SS262L	—	—	—	—

Combination Wallplates

Combination, Nylon, Standard Wallplates

Color	2-Gang, 1-Toggle 1-Decorator	2-Gang, 1-Duplex, 1-Decorator	2-Gang, 1-Blank Box Mount 1-Decorator	3-Gang, 2-Toggle 1-Decorator	3-Gang, 1-Toggle 2-Decorator	4-Gang, 3-Toggle 1-Decorator	4-Gang, 2-Toggle 2-Decorator
Black	NP126BK	NP826BK	NP1326BK	NP226BK	NP1262BK	NP326BK	NP2262BK
Brown	NP126	NP826	NP1326	NP226	NP1262	NP326	NP2262
Gray	NP126GY	NP826GY	NP1326GY	NP226GY	NP1262GY	NP326GY	NP2262GY
Ivory	NP126I	NP826I	NP1326I	NP226I	NP1262I	NP326I	NP2262I
Light Almond	NP126LA	NP826LA	NP1326LA	NP226LA	NP1262LA	NP326LA	NP2262LA
White	NP126W	NP826W	NP1326W	NP226W	NP1262W	NP326W	NP2262W

Combination, Nylon, Mid-Size Wallplates

Color	2-Gang, 1-Toggle 1-Decorator	2-Gang, 1-Duplex, 1-Decorator	2-Gang, 1-Blank Box Mount 1-Decorator	3-Gang, 2-Toggle 1-Decorator	3-Gang, 1-Toggle 2-Decorator	4-Gang, 3-Toggle 1-Decorator	4-Gang, 2-Toggle 2-Decorator
Black	NPJ126BK	NPJ826BK	—	NPJ226BK	—	—	—
Brown	NPJ126	NPJ826	NPJ1326	NPJ226	—	—	—
Gray	NPJ126GY	NPJ826GY	—	NPJ226GY	—	—	—
Ivory	NPJ126I	NPJ826I	NPJ1326I	NPJ226I	—	—	—
Light Almond	NPJ126LA	NPJ826LA	NPJ1326LA	NPJ226LA	—	—	—
White	NPJ126W	NPJ826W	NPJ1326W	NPJ226W	—	—	—

Combination, Standard, Metal Wallplates

Material	2-Gang, 1-Toggle 1-Decorator	2-Gang, 1-Duplex, 1-Decorator	2-Gang, 1-Blank Strap Mount 1-Decorator	3-Gang, 2-Toggle 1-Decorator	3-Gang, 1-Toggle 2-Decorator	4-Gang, 3-Toggle 1-Decorator	4-Gang, 2-Toggle 2-Decorator
Brass	SB126	SB826	—	—	—	—	—
Brass Plated	SBP126	—	—	—	—	—	—
Chrome	—	—	—	—	—	—	—
SS 302/304	SS126	SS826	SS1426	SS226	—	SS326	—
SS 430	SS126L	—	—	—	—	—	—

Note: See section N for complete selection of wallplates.

Dimensions

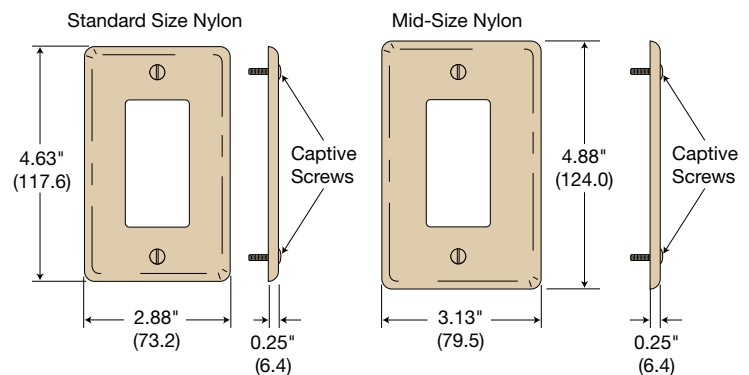
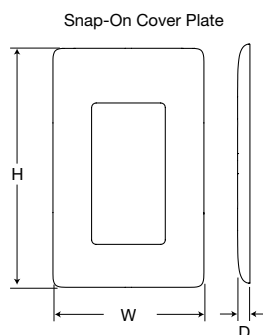

Gang	Height (H)	Width (W)	Depth (D)
1	4.75" (120.6)	3.00" (76.2)	.25" (6.2)
2	4.75" (120.6)	4.81" (122.2)	.25" (6.2)
3	4.75" (120.6)	6.62" (168.2)	.25" (6.2)
4	4.75" (120.6)	8.44" (214.3)	.25" (6.2)



Toggle Switches

Features



Standard toggle switches provide the basic ON/OFF control for home lighting and appliances.

- Tough thermoplastic with ultrasonically welded cover and base
- Elongated strap for easier wall box mounting
- Quiet snap action mechanism
- Multiple-drive Slot/Phillips/Robertson head screws
- Hi-visibility yellow base for easy installation
- Operating temperature: -20°C to 60°C
- UL Listed E3896, CSA Certified







RS115W

Single Pole Toggle Switches

Description	Single Pole	Single Pole	Single Pole, Illuminated
Termination	Grounding, Push and Side Wire	Self-Grounding, Push and Side Wire	Self-Grounding, Push and Side Wire
Rating	15A 120V AC	15A 120V AC	15A 120V AC
			
Color			
Clear	—	—	RS115ILC
Black	RS115BK	—	—
Brown	RS115	RS115S	—
Ivory	RS115I	RS115SI	RS115ILI*
Light Almond	RS115LA	RS115SLA	RS115ILLA*
White	RS115W	RS115SW	RS115ILW*

Note: *Frame is clear and illuminates, toggle is colored. Does not require a neutral wire.

Three and Four Way Toggle Switches

Description	Three Way	Three Way	Three Way, Illuminated	Four Way
Termination	Grounding, Push and Side Wire	Self-Grounding, Push and Side Wire	Self-Grounding, Push and Side Wire	Self-Grounding, Side Wire
Rating	15A 120V AC	15A 120V AC	15A 120V AC	15A 120V AC
				
Color				
Clear	—	—	RS315ILC	—
Black	RS315BK	—	—	—
Brown	RS315	RS315S	—	RS415
Ivory	RS315I	RS315SI	RS315ILI*	RS415I
Light Almond	RS315LA	RS315SLA	RS315ILLA*	RS415LA
White	RS315W	RS315SW	RS315ILW*	RS415W

Note: *Frame is clear and illuminates, toggle is colored. Does not require a neutral wire.

Dimensions in Inches (mm)

Combination Switches/Devices

Features

Mini-toggles provide for multiple switches in a compact single gang. Maximize control while maintaining function and appearance.

- Low profile, less than 1 inch
- Self-grounding feature is standard
- Combination devices provide compact switches in a single-gang opening
- Smooth toggle action
- Multiple-drive Slot/Phillips/Robertson head screws
- Hi-visibility yellow base for easy installation
- Operating temperature: -20°C to 60°C
- UL Listed, CSA Certified



RC108I

Combination Toggle Switches/Devices

Description	Two (2) Single Pole Switches	Single Pole Switch, Tamper-Resistant, 2 Pole, 3 Wire, Receptacle	Single Pole Switch, 2 Pole, 3 Wire, Receptacle	Single Pole Switch, Pilot Light, Clear Lens, Amber Neon Bulb*
Termination	Self-Grounding, Side Wire	Self-Grounding, Side Wire	Self-Grounding, Side Wire	Self-Grounding, Side Wire
Rating	15A 120V AC	15A 120V (switch) 15A 125V (recept.) NEMA 5-15R	15A 120V (switch) 15A 125V (recept.) NEMA 5-15R	15A 120V AC
Color				
Brown	RC101	RC108TR	RC108	RC109
Ivory	RC101I	RC108ITR	RC108I	RC109I
Light Almond	RC101LA	RC108LATR	RC108LA	RC109LA
White	RC101W	RC108WTR	RC108W	RC109W

Note: See page Tech-10 for Tamper-Resistant description.
*Neutral required for pilot light, see page X-4 for wiring diagram.

Combination Toggle Switches/Devices

Description	Single Pole and Three Way Switch	Two (2) Three Way Switches	Three Way Switch, Tamper-Resistant, 2 Pole, 3 Wire, Receptacle	Three Way Switch, 2 Pole, 3 Wire, Receptacle	Three Way Switch, Pilot Light, Clear Lens, Amber Neon Bulb*
Termination	Self-Grounding, Side Wire	Self-Grounding, Side Wire	Self-Grounding, Side Wire	Self-Grounding, Side Wire	Self-Grounding, Side Wire
Rating	15A 120V AC	15A 120V AC	15A 120V (switch) 15A 125V (recept.) NEMA 5-15R	15A 120V (switch) 15A 125V (recept.) NEMA 5-15R	15A 120V AC
Color					
Brown	RC103	RC303	RC308TR	RC308	RC309
Ivory	RC103I	RC303I	RC308ITR	RC308I	RC309I
Light Almond	RC103LA	RC303LA	RC308LATR	—	—
White	RC103W	RC303W	RC308WTR	RC308W	RC309W

Note: See page Tech-10 for Tamper-Resistant description.
*Neutral required for pilot light, see page X-4 for wiring diagram.

Dimensions in Inches (mm)



Duplex and Single Receptacles

Duplex Receptacles, 2 Pole, 3 Wire



Description		Standard			Standard
	Tamper-Resistant, Quick Thread		Weather and Tamper-Resistant	Tamper-Resistant	
Termination	Self-Grounding, Push and Side Wire	Grounding, Push and Side Wire	Self-Grounding, Push and Side Wire	Self-Grounding, Push and Side Wire	Self-Grounding, Push and Side Wire
Rating	15A 125V NEMA 5-15R	15A 125V NEMA 5-15R	15A 125V NEMA 5-15R	15A 125V NEMA 5-15R	15A 125V NEMA 5-15R
Black	RR15QBKTR	RR15BK	RR15SBKWRTR	RR15SBKTR	RR15SBK
Brown	RR15QTR	RR15	RR15SWRTR	RR15STR	RR15S
Gray	—	—	RR15SGYWRTR	—	—
Ivory	RR15QITR	RR15I	RR15SIWRTR	RR15SITR	RR15SI
Light Almond	RR15QLATR	RR15LA	RR15SLAWRTR	RR15SLATR	RR15SLA
White	RR15QWTR	RR15W	RR15SWWRTR	RR15SWTR	RR15SW



Description				Standard, Without Ears*
	Tamper-Resistant, Quick Thread	Tamper-Resistant,	Tamper-Resistant, Without Ears*	
Termination	Eight Push Wire Holes Only #14 AWG	Eight Push Wire Holes Only #14 AWG	Eight Push Wire Holes Only #14 AWG	Eight Push Wire Holes Only #14 AWG
Rating	15A 125V NEMA 5-15R	15A 125V NEMA 5-15R	15A 125V NEMA 5-15R	15A 125V NEMA 5-15R
Black	RR15EQBKTR	RR15EBKTR	—	—
Brown	RR15EQTR	RR15ETR	RR15KTR	RR15K
Gray	—	RR15EGYTR	—	—
Ivory	RR15EQITR	RR15EITR	RR15KITR	RR15KI
Light Almond	RR15EQLATR	RR15ELATR	RR15KLATR	—
White	RR15EQWTR	RR15EWTR	RR15KWTR	RR15KW

Note: See page Tech-10 for Weather and Tamper-Resistant descriptions.
*100 per case, bulk packed. Mounting screws inserted into strap.

Single Receptacles, 2 Pole, 3 Wire



Description			Standard		Standard
	Weather and Tamper-Resistant	Tamper-Resistant		Weather Resistant	
Termination	Self-Grounding, Side Wire	Self-Grounding, Side Wire	Self-Grounding, Side Wire	Self-Grounding, Side Wire	Self-Grounding, Side Wire
Rating	15A 125V NEMA 5-15R	15A 125V NEMA 5-15R	15A 125V NEMA 5-15R	15A 250V NEMA 6-15R	15A 250V NEMA 6-15R
Black	RR151BKWRTR	RR151BKTR	RR151BK	RR155BKWR	RR155BK
Brown	RR151WRTR	RR151TR	RR151	RR155WR	RR155
Gray	RR151GYWRTR	RR151GYTR	RR151GY	RR155GYWR	RR155GY
Ivory	RR151IWRTR	RR151ITR	RR151I	RR155IWR	RR155I
Light Almond	RR151LAWRTR	RR151LATR	RR151LA	RR155LAWR	RR155LA
White	RR151WWRTR	RR151WTR	RR151W	RR155WWR	RR155W

RR15W



Description			Standard		Standard
	Weather and Tamper-Resistant	Tamper-Resistant		Weather Resistant	
Termination	Self-Grounding, Side Wire	Self-Grounding, Side Wire	Self-Grounding, Side Wire	Self-Grounding, Side Wire	Self-Grounding, Side Wire
Rating	20A 125V NEMA 5-20R	20A 125V NEMA 5-20R	20A 125V NEMA 5-20R	20A 250V NEMA 6-20R	20A 250V NEMA 6-20R
Black	RR201BKWRTR	RR201BKTR	RR201BK	RR205BKWR	RR205BK
Brown	RR201WRTR	RR201TR	RR201	RR205WR	RR205
Gray	RR201GYWRTR	RR201GYTR	RR201GY	RR205GYWR	RR205GY
Ivory	RR201IWRTR	RR201ITR	RR201I	RR205IWR	RR205I
Light Almond	RR201LAWRTR	RR201LATR	RR201LA	RR205LAWR	RR205LA
White	RR201WWRTR	RR201WTR	RR201W	RR205WWR	RR205W





RR201W

Note: See page Tech-10 for Weather and Tamper-Resistant descriptions.

Dimensions in Inches (mm)

Range and Dryer Power Receptacles and Plugs





Range and Dryer Power Receptacles

				
Description	Flush Mount for 1- or 2-Gang Box	Flush Mount for 1- or 2-Gang Box	Flush Mount for 1- or 2-Gang Box	Flush Mount for 1- or 2-Gang Box
Rating	30A 125/250V 3 Pole, 4 Wire with Ground	50A 125/250V 3 Pole, 4 Wire with Ground	30A 125/250V 3 Pole, 3 Wire without Ground	50A 125/250V 3 Pole, 3 Wire without Ground
Black	RR430F	RR450F	RR330F*	RR350F*
White	RR430FW	RR450FW	—	—
<hr/>				
Description	Surface Mount	Surface Mount	Surface Mount	Surface Mount
Rating	30A 125/250V 3 Pole, 4 Wire with Ground	50A 125/250V 3 Pole, 4 Wire with Ground	30A 125/250V 3 Pole, 3 Wire without Ground	50A 125/250V 3 Pole, 3 Wire without Ground
Black	RR430	RR450	RR330*	RR350*
<hr/>				
Description	Panel Mount	Panel Mount		
Rating	30A 125/250V 3 Pole, 4 Wire with Ground	50A 125/250V 3 Pole, 4 Wire with Ground		
Black	RR430PM	RR450PM		
White	—	—		

Note: *For replacement use only.



Range and Dryer Power Angled Plugs

				
Description	With Interchangeable Blades for 30 or 50 Amp		With Interchangeable Blades for 30 or 50 Amp	
Rating	30/50A 125/250V 3 Pole, 4 Wire with Ground		30/50A 125/250V 3 Pole, 3 Wire without Ground	
Black	RR435P		RR335P	



Wallplates, Surface Mount, 2.15" Diameter Single Hole

Description	1-Gang Standard	1-Gang Mid size	2-Gang Standard	2-Gang Mid size
Ivory	NP724I	NPJ724I	NP703I	NPJ703I
White	NP724W	NPJ724W	NP703W	NPJ703W
Chrome	SCH723	—	—	—
Stainless Steel	SS723	—	SS703	—



Dimensions in Inches (mm)



Special Use Products



Special Use Products



RR151CHW



RR1510W



RJ650BK



Dividers



RJ600



RDS50



RS100W



RS101W

Description	Color	Tamper-Resistant	Tamper-Resistant
Clock Hanger/Recessed Single Receptacle Tamper-Resistant, 2 pole, 3 wire, grounding, side wire terminations	Brass Stainless Steel Ivory (Nylon) White (Nylon)	RR151CHBSTR RR151CHSSTR RR151CHITR RR151CHWTR	RR201CHBSTR RR201CHSSTR RR201CHITR RR201CHWTR
Recessed Duplex Receptacle Tamper-Resistant, 2 pole, 3 wire, grounding, side wire terminations	Ivory Light Almond White	RR1510I RR1510LA RR1510W	— — —
JLOAD® Multimedia Outlet Provides power, Cat. 5e and coaxial in a single gang box. Requires RJ600 Box. Includes decorator frame, one Cat. 5e, one F-connector and one power receptacle 125V with voltage dividers.	Black Gray Ivory Light Almond White	RJ650BKTR RJ650GYTR RJ650ITR RJ650LATR RJ650WTR	RJ620BKTR RJ620GYTR RJ620ITR RJ620LATR RJ620WTR
JLOAD® Multimedia Outlet Includes decorator frame with two open ports for custom configuration and one power receptacle 125V with voltage dividers.	Black Gray Ivory Light Almond White	RJ65BKTR RJ65GYTR RJ65ITR RJ65LATR RJ65WTR	RJ62BKTR RJ62GYTR RJ62ITR RJ62LATR RJ62WTR
JLOAD® Multimedia Box 3 inches deep with seven ½-inch knockouts, non-metallic sheathed cable clamps on each side. Screw in mounting to stud.	Steel	RJ600	RJ600

Note: See pages X-24 to X-29 for floor boxes and under cabinet power distribution options.
See page Tech-10 for Tamper-Resistant description.

Door Switch with Cover Plate and Box

Description	"ON" when Door is Open	"OFF" when Door is Open
Rating	3A 125V AC	3A 125V AC
Zinc Plated Steel	RDS50*	RDS30*

Note: *Not UL Listed.

Dimensions

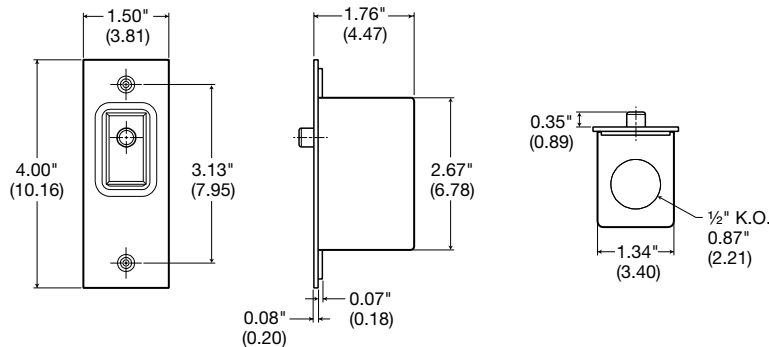

In-Line Cord Switches

Description	Mini For Use with Flat Lamp Cord	Heavy Duty
Rating	6A 125V AC	6A 125V AC, 1/6 HP
Wire	#18 AWG SPT 1 and SPT 2	#18 to #16 AWG SPT 1 and SPT 2
Ivory White	— RS100W	RS101I RS101W

Dimensions in Inches (mm)

CFL/LED, Toggle, Rotary Dimmers and Fan Speed Controls

Features

Standard toggle switches provide the basic ON/OFF control for home lighting and appliances.

- Optimum CFL and LED Control
- Low End Adjustment for Fine Tuning
- Decorator and Traditional Toggle Styling Available
- No Neutral Required



RAYCL153PW

Adjustment dial to set the low-light level



CFL/LED Dimmers

Description	Decorator Dimmer	Toggle Dimmer
Rating	CFL/LED 150W Incandescent/ Halogen 600W 120V AC, 60Hz	CFL/LED 150W Incandescent/ Halogen 600W 120V AC, 60Hz
Termination	Single Pole/Three Way	Single Pole/Three Way
Ivory	RDVCL153PI	RAYCL153PI
Light Almond	RDVCL153PLA	RAYCL153PLA
White	RDVCL153PW	RAYCL153PW



RDVCL153PW

Toggle Incandescent Preset Dimmers

Description	Side Slide Adjustment with Wire Leads	Side Slide Adjustment with Wire Leads	Side Slide Adjustment with Terminal Screws	Side Slide Adjustment with Terminal Screws
Termination	Single Pole	Three Way	Single Pole	Three Way
Rating	1000W 120V AC	1000W 120V AC	600W 120V AC	600W 120V AC
Ivory	RAY10PI	RAY103PI	RAY600PI	RAY603PI
Light Almond	RAY10PLA	RAY103PLA	RAY600PLA	RAY603PLA
White	RAY10PW	RAY103PW	RAY600PW	RAY603PW



RAY600PW

Rotary Incandescent Dimmers

Description	On/Off Dimmer	Push ON/OFF Dimmer Ivory and White Knobs Provided	Push ON/OFF Dimmer Ivory and White Knobs Provided
Termination	Single Pole	Single Pole	Three Way
Rating	600W 120V AC	600W 120V AC	600W 120V AC
Ivory	RD600RI	—	—
White	RD600RW	—	—
Ivory/White	—	RD600PDK	RD603PDK

Replacement Knobs

2 Piece Kit
Replacement Knobs

—
—
—
RRKDK



RFSQ2FDK

Fan Speed Controls

Description	Toggle 3-Speed	Combination Toggle 3-Speed/Dimmer	Rotary ON/OFF 3-Speed Ivory and White Knobs Provided	Rotary Variable Speed
Termination	Single Pole or Three Way	Single Pole	Single Pole	Single Pole
Rating	1.5A 120V AC	300W 1.5A 120V AC	1.5A 120V AC	5A 120V AC
Ivory	RAYFSQFI	RAY2LFSQI	—	RFS5I
Light Almond	RAYFSQFLA	RAY2LFSQLA	—	RFS5LA
White	RAYFSQFW	RAY2LFSQW	—	RFS5W
Ivory/White	—	—	RFSQ2FDK	—

Replacement Knobs

Rotary Fan Control
Replacement Knobs

—
—
R28032406
—
R28032401
—



R28032401
R28032406

Dimensions in Inches (mm)



Dimmers and Fan Speed Controls



RDV600PW

Rocker Decorator Dimmers, Preset with Night Light

Description	Side Slide Adjustment, Incandescent	Side Slide Adjustment, Incandescent	Side Slide Adjustment, Incandescent	Side Slide Adjustment, Incandescent
Termination	Single Pole	Three Way	Single Pole	Three Way
Rating	1000W 120V AC	1000W 120V AC	600W 120V AC	600W 120V AC
Ivory	RDV10PI	RDV103PI	RDV600PI	RDV603PI
Light Almond	RDV10PLA	RDV103PLA	RDV600PLA	RDV603PLA
White	RDV10PW	RDV103PW	RDV600PW	RDV603PW



RS600PW

Description	Magnetic Low Voltage	Magnetic Low Voltage	Electronic Low Voltage	Electronic Low Voltage Requires Neutral
Termination	Single Pole	Three Way	Single Pole	Three Way
Rating	600VA (450W) 120V AC	600VA (450W) 120V AC	300W 120V AC	300W 120V AC
Ivory	RDVLV600PI	RDVLV603PI	RDVELV300PI	RDVELV303PI
Light Almond	RDVLV600PLA	RDVLV603PLA	RDVELV300PLA	RDVELV303PLA
White	RDVLV600PW	RDVLV603PW	RDVELV300PW	RDVELV303PW



RS600W

Slide Dimmers, Preset with ON/OFF Switch

Description	Incandescent	Incandescent	Incandescent	Incandescent
Termination	Single Pole	Three Way	Single Pole	Three Way
Rating	1000W 120V AC	1000W 120V AC	600W 120V AC	600W 120V AC
Ivory	RS10PI	RS103PI	RS600PI	RS603PI
Light Almond	RS10PLA	RS103PLA	RS600PLA	RS603PLA
White	RS10PW	RS103PW	RS600PW	RS603PW



RS613PW

Description	Magnetic Low Voltage	Magnetic Low Voltage	Electronic Low Voltage	Electronic Low Voltage Requires Neutral
Termination	Single Pole	Three Way	Single Pole	Three Way
Rating	600VA (450W) 120V AC	600VA (450W) 120V AC	300W 120V AC	300W 120V AC
Ivory	RSLV600PI	RSLV603PI	RSELV300PI	RSELV303PI
Light Almond	RSLV600PLA	RSLV603PLA	RSELV300PLA	RSELV303PLA
White	RSLV600PW	RSLV603PW	RSELV300PW	RSELV303PW

Slide Dimmers, Slide to OFF

Description	Incandescent Slide to OFF	Incandescent Omni Slide Button
Termination	Single Pole	Single Pole/Three Way
Rating	600W 120V AC	600W 120V AC
Ivory	RS600I	RS613PI
Light Almond	RS600LA	RS613PLA
White	RS600W	RS613PW



RS2LFSQW

Fan Speed Controls, 3 Speed

Description	Rocker Slide Adjustment	Slide Control Slide to OFF	Combination Slide Dimmer, Incandescent
Termination	Single Pole/Three Way	Single Pole	Single Pole
Rating	1.5A 120V AC	1.5A 120V AC	300W 1.5A 120V AC
Ivory	RDVFSQFI	RSFSQFI	RS2LFSQI
Light Almond	RDVFSQFLA	RSFSQFLA	RS2LFSQLA
White	RDVFSQFW	RSFSQFW	RS2LFSQW

Replacement Knobs

Description	Slide Control Replacement Knobs
Termination	—
Rating	—
Ivory	RSKI
Light Almond	RSKLA
White	RSKW

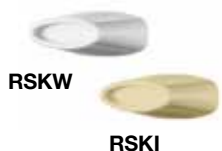

Wall Switches and Digital Timer

Passive Infrared Wall Switches

- Passive infrared technology
- Photo-cell (WS2000 series)
- No neutral required
- 1200 sq. ft. coverage
- Steel mounting strap
- Compatible with most LED and CFL
- CEC Title 24 and ASHRAE 90.1 compliant
- cULus

Description	Color	Standard	with Nightlight	with Neutral	with Nightlight and Neutral
Manual adjusting; selectable manual/auto-ON operation; dual-voltage 120/277V AC; 3-way capable	Gray	WS2000GY	WS2000NGY	—	—
	Ivory	WS2000I	WS2000NI	WS2004I	WS2004NI
	Light Almond	WS2000LA	WS2000NLA	—	—
	White	WS2000W	WS2000NW	WS2004W	WS2004NW
Manual adjusting; auto-ON operation; 120V AC only	Ivory	WS1000I	WS1000NI	—	—
	Light Almond	WS1000LA	—	—	—
	White	WS1000W	WS1000NW	—	—
Manual adjusting; Manual-ON operation; 120V AC only	Ivory	WS1001I	WS1001NI	—	—
	White	WS1001W	WS1001NW	—	—

Note: See below for coverage patterns.



Two-Circuit, Independent Settings

Description	Color	Standard	with Neutral
Manual adjustments; Auto-ON operation; 120V AC	Gray	WS1020GY	WS1024GY
	Ivory	WS1020I	WS1024I
	Light Almond	WS1020LA	WS1024LA
	White	WS1020W	WS1024W
Manual adjustments; Manual-ON operation; 120V AC	Gray	WS1021GY	WS1025GY
	Ivory	WS1021I	WS1025I
	Light Almond	WS1021LA	WS1025LA
	White	WS1021W	WS1025W

Count Down Timer Wall Switch

Description	Color	30 Minutes: OFF, 5, 10, 20, 30	60 Minutes: OFF, 15, 30, 45, 60	12 Hours: OFF, 2, 4, 8, 12
1000W @ 120V AC and 1400W @ 277V AC	Ivory	DT5030I	DT5060I	DT5012I
	Light Almond	DT5030LA	DT5060LA	DT5012LA
	White	DT5030W	DT5060W	DT5012W

Note: Neutral required.

Digital Timer Wall Switch

Description	Color	120V AC	277V AC	Catalog Number
Dip switch enabled preset intervals. User adjustable 1 min up to 4 hours, 3-way capable. Includes an ON/OFF momentary push button switch feature.	White	960W	1200W	DT2000W

Note: Neutral required.

Wall Switches Coverage Patterns

Minor Motion: ■ PIR Major Motion: ■ PIR

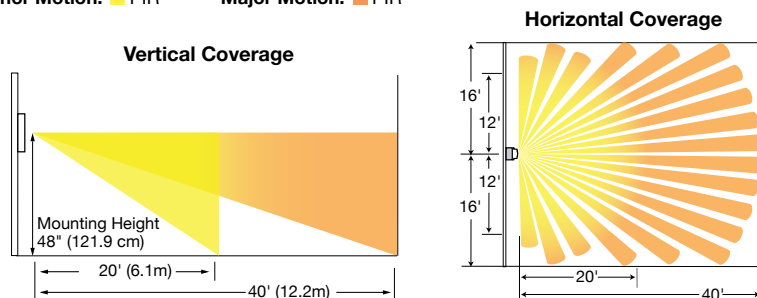

WS1000, WS2000 Series



Floor Boxes for Wood Floors

Hubbell Wood Floor Boxes allow for the placement of electrical power or a combination of power and voice/data devices. Specifically designed for use with structural wood floors. The boxes are height adjustable (up to ¾ inch) for optimal alignment and fit.

Features

- Available surface mount or flush fit
- Pre-assembled flange and cover for fast installation
- Removable neoprene gaskets allow for independent use of either side of the receptacle with the cover closed
- Low voltage divider optional provides for power and voice/data in a compact space
- Height accessible adjustments after the box is mounted
- Back and side knockouts for proper wiring access
- Recessed receptacle minimizes plug protrusion; allowing furniture to be located over the plug
- Top screw fastening and side joist mounting provided



**RF509BR, RJ650BK,
RF500 with Divider**

Note: Template cutout provided with instructions for proper installation.

The Right Choice for that Perfect Finishing Touch!



Solid Brass Brass Plated Chrome Plated Copper Plated Nickel Plated Stainless Finish Almond Black Chestnut Brown

Note: Not all configurations are available in all colors. See below for details.



RF515BR



RF509BR



RF500



RF507BR

Floor Boxes for Structural Wood Floors

Description	Material	Finish	Catalog No.	Material	Finish	Catalog No.
Decorator duplex receptacle floor box kit; includes steel box, flange and hinged door cover assembly with 15A 125V tamper-resistant duplex receptacle; designed for installation in wood floors; mounts to sub-floor or joists.	Solid Brass	Clear Lacquer	RF515BR	Aluminum	Brass Plated	RF515BP
	Aluminum	Stainless Paint	RF515SS	Aluminum	Chrome Plated	RF515CH
	Aluminum	Almond Paint	RF515AL	Aluminum	Copper Plated	RF515CU
	Aluminum	Black Paint	RF515BK	Aluminum	Nickel Plated	RF515NI
	Aluminum	Chestnut Brown Paint	RF515BN			
Flange and hinged door cover assembly; includes tamper-resistant duplex receptacle; neoprene gaskets; for use with steel box RF500.	Solid Brass	Clear Lacquer	RF506BR	Aluminum	Brass Plated	RF506BP
	Aluminum	Stainless Paint	RF506SS	Aluminum	Chrome Plated	RF506CH
	Aluminum	Almond Paint	RF506AL	Aluminum	Copper Plated	RF506CU
	Aluminum	Black Paint	RF506BK	Aluminum	Nickel Plated	RF506NI
	Aluminum	Chestnut Brown Paint	RF506BN			
Flush fit cover for hardwood and tile floors (similar to above).	Solid Brass	Clear Lacquer	RF509BR			
Adjustable floor box; 3 inch deep; three (3) ½ inch knockouts: one on bottom; one on each side; non-metallic sheathed cable clamps on each side.				Steel	—	RF500
Hinged Door Cover Only Replacement door for RF515, RF509 and RF506 series.	Solid Brass	Solid Brass	RF507BR	Aluminum	Brass Plated	RF507BP
	Aluminum	Stainless Finish	RF507SS	Aluminum	Chrome Plated	RF507CH
	Aluminum	Almond	RF507AL	Aluminum	Copper Plated	RF507CU
	Aluminum	Black	RF507BK	Aluminum	Nickel Plated	RF507NI
	Aluminum	Chestnut Brown Paint	RF507BN			

Dimensions in Inches (mm)

Floor Boxes for Wood Floors

Features

Duplex floor receptacles provide ample connections to service lighting, entertainment equipment and computers for family rooms and offices. Single receptacle configurations available for minimum requirements.

- Low profile, solid brass flange and cover
- Cut out template provided to assure proper sub-flooring preparation
- Line and low voltage options
- 2½ inch hole, ample wiring room
- For use with single or feed through service



RF151R

Drop-In Floor Box

Drop-In Floor Boxes are perfect for quick and easy installation of power or low voltage. Simply cut a hole between the floor and joists and drop through. The flange lip holds it in place.



Floor Boxes for Wood Floors



Description	Material	Catalog Number	Catalog Number
Drop In Floor Box Mounts in 2½ inch hole opening. Includes solid brass cover, single tamper-resistant receptacle, optional device mounts for two (2) voice/data video ports. Suitable for feed through circuitry. Impact resistant box.	Solid Brass	RF151R	RF201R
Duplex Receptacle Floor Box Rated Includes steel box, duplex TR receptacle and cover.	Solid Brass	RF6500BR	—
Single Receptacle Floor Box Rated Includes steel box, single receptacle and cover.	Solid Brass	RF151TR	—
Single Receptacle Display Rated Receptacle and cover only, excludes box.	Solid Brass	RF151DTR	—

Note: See page Tech-10 for Tamper-Resistant description.

RF151R

RF6500BR

Dimensions

Wood Floor Boxes

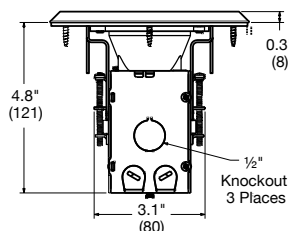
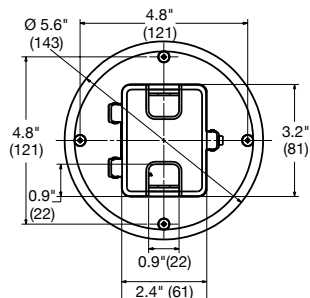

Drop-In Floor Box

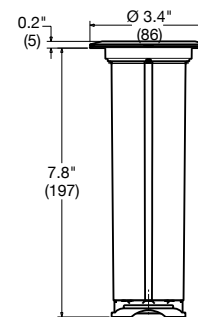
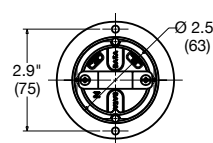

RF151TR

RF151DTR

Dimensions in Inches (mm)



Floor Boxes for Concrete Floors

Residential Round Non-Metallic Floor Box offers an economical solution for electrical power or a combination of power and voice/data applications. Designed specifically for slab-on-grade installation. Quick and easy installation is assured using a push in place leveling system. UL Listed E92074.

Features

After the box has been secured in concrete, cut for height, apply PVC glue and push the cover assembly into the box. No fasteners or adjustment screws required.

- 4 inch minimum concrete pour
- Removable neoprene gaskets allow for independent use of either side of the receptacle with the cover closed
- Recessed GFCI/Decorator opening
- Self height and leveling ring, no adjustments
- Pre-assembled flange, cover and leveling ring for quick installation
- Parallel PVC hubs for 1 inch and ¾ inch conduit
- TR receptacle included
- UL Listed E92074 Floor Box



RF406BK
with RF400



RF406ALU



RF406BK



RF409BR



RF408



RJ650BK

Floor Boxes for Concrete Floors

Description	Rating	Material/Color	Catalog Number
Flange and Hinged Door Cover Assembly Includes duplex TR receptacle, gasket, floor leveling PVC ring, high impact and chemically resistant nylon. Factory pre-assembled for easy drop-in installation.	15A 125V NEMA 5-15R	Brushed Aluminum Brushed Brass Plated Solid Brass Almond Black Chestnut Brown Gray	RF406ALU RF406BP RF406BR RF406AL RF406BK RF406BN RF406GY
Flush fit cover for hardwood and tile floors (similar to above).		Solid Brass	RF409BR
PVC Floor Box with Concrete Protective Cover Accepts ¾ in. and 1.0 in. schedule 40 and schedule 80 PVC conduit. Includes round box (47/8 in. diameter x 6.0 in. deep), four reducers, closure plugs, and concrete cover with locator flag.		Gray	RF400
Hinged Nylon Replacement Door Cover Includes neoprene gasket to seal plug openings. Replacement cover for RF406 series.		Solid Brass Almond Black	RF407BR RF407AL RF407BK
Low Voltage Divider For use in PVC box RF400, when JLOAD® Multimedia Outlet is used.		Gray	RF408



JLOAD® Multimedia Outlet

Description	Color	Tamper-Resistant	Tamper-Resistant
JLOAD® Multimedia Outlet Specifically designed to provide power, Cat. 5e and coaxial in a single gang box. Requires Low Voltage Divider RF408 when used in PVC Box RF400. Perfect for HDTV and computer use where a combination of power and data are needed. Includes decorator frame, one Cat. 5e, one F-connector and one power receptacle 125V with voltage dividers.	Black Gray Ivory Light Almond White	RJ650BKTR RJ650GYTR RJ650ITR RJ650LATR RJ650WTR	RJ620BKTR RJ620GYTR RJ620ITR RJ620LATR RJ620WTR
JLOAD® Multimedia Outlet Includes decorator frame with two open ports for custom configuration and one power receptacle 125V with voltage dividers.	Black Gray Ivory Light Almond White	RJ65BKTR RJ65GYTR RJ65ITR RJ65LATR RJ65WTR	RJ62BKTR RJ62GYTR RJ62ITR RJ62LATR RJ62WTR

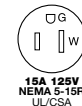

Note: See page Tech-10 for Tamper-Resistant description.

Under Cabinet/Counter Power Distribution

Features

These boxes comply with the NEC® for kitchen receptacles, with placement not more than 20 inches above the counter surface. They can also be placed under counter islands, not lower than 15 inches from the surface.

- Available with nylon or metal cover
- Custom configurable, accepts any decorator style device
- Mounting hardware included
- UL Listed E31999 and CSA Certified under cabinet boxes



Under Cabinet/Counter Power Distribution

Description	Material	Catalog Number
Slim Box	Stainless Steel	RU100SS
	White Metal	RU100W
	White Nylon	RU170W*
GFCI Fit Box	Stainless Steel	RU200SS
	White Metal	RU200W
	White Nylon	RU270W*

Note: *Steel box with nylon cover.



RU100W



RU200SS

Dimensions

Slim Box

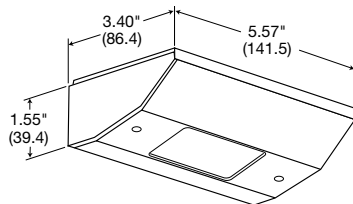

GFCI Fit Box

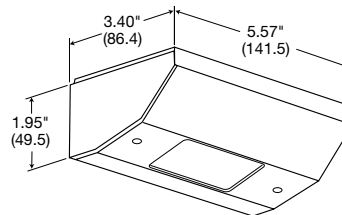

Vertical Mount

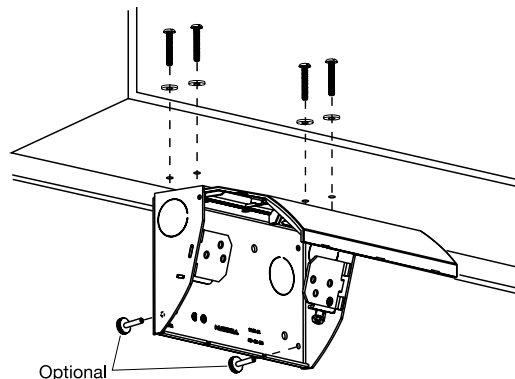

Horizontal Mount

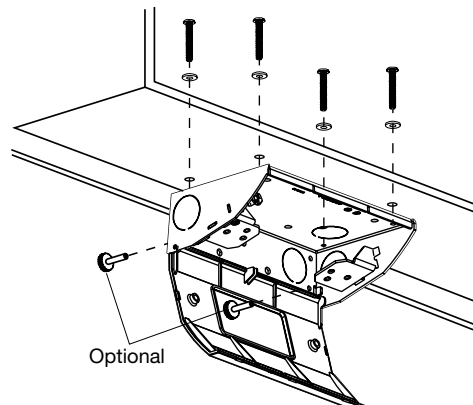

NEC® is a registered trademark of the National Fire Protection Association (NFPA).

Dimensions in Inches (mm)



JLOAD® Multimedia Outlet

Make the Most of a Perfect Location

Install receptacles and voice/data devices exactly where they are needed, in the smallest space possible.

Features

After the box has been secured in concrete, cut for height, apply PVC glue and push the cover assembly into the box. No fasteners or adjustment screws required.

- Accepts any snap fit jack configuration (see page X-10)
- Isolates low voltage and power in the same box
- Custom box mounting
- Provides for data, telephone and coaxial
- Available in 15 or 20 Amp



RJ620W

Note: Requires unique box shown below.



Special Use Products



RJ620W



RJ62W



Dividers



RJ600

Dimensions in Inches (mm)

Description	Color	Tamper-Resistant	Tamper-Resistant
JLOAD® Multimedia Outlet Specifically designed to provide power, Cat. 5e and coaxial in a single gang box. Requires JLOAD® Multimedia Box RJ600. Perfect for HDTV and computer use where a combination of power and data are needed. Includes decorator frame, one Cat. 5e, one F-connector and one power receptacle 125V with voltage dividers.	Black	RJ650BKTR	RJ620BKTR
	Gray	RJ650GYTR	RJ620GYTR
	Ivory	RJ650ITR	RJ620ITR
	Light Almond	RJ650LATR	RJ620LATR
	White	RJ650WTR	RJ620WTR
JLOAD® Multimedia Outlet Includes decorator frame with two open ports for custom configuration and one power receptacle 125V with voltage dividers.	Black	RJ65BKTR	RJ62BKTR
	Gray	RJ65GYTR	RJ62GYTR
	Ivory	RJ65ITR	RJ62ITR
	Light Almond	RJ65LATR	RJ62LATR
	White	RJ65WTR	RJ62WTR
JLOAD® Multimedia Box 3 inches deep with seven ½-inch knockouts, non-metallic sheathed cable clamps on each side. Screw in mounting to stud.	Steel	RJ600	RJ600

Note: See page Tech-10 for Tamper-Resistant description.

Dimensions

